

1

2

3

4

5

6

RevNo	Revision note	Date	Signature	Checked
-------	---------------	------	-----------	---------

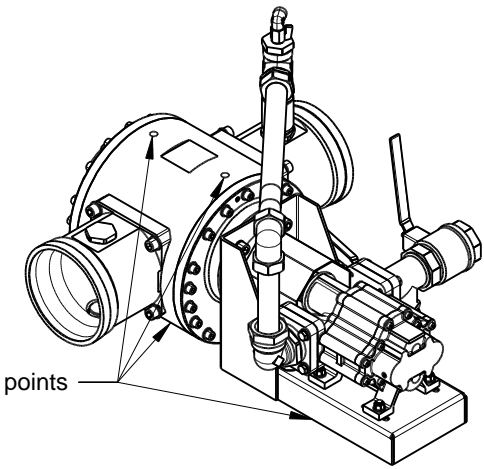
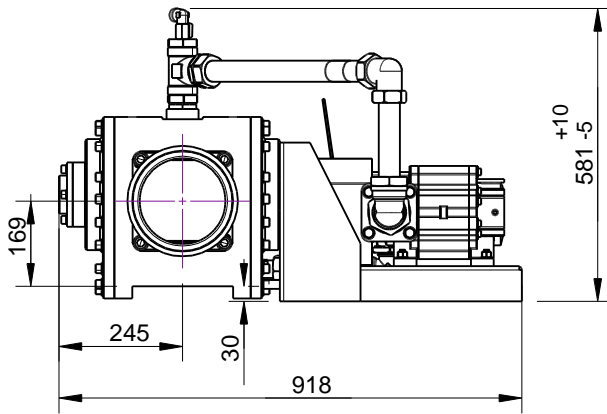
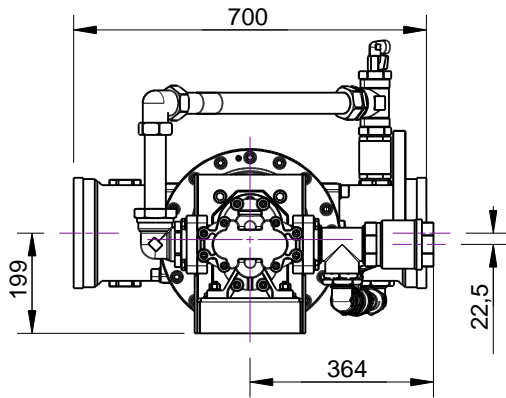

A

A

B

B

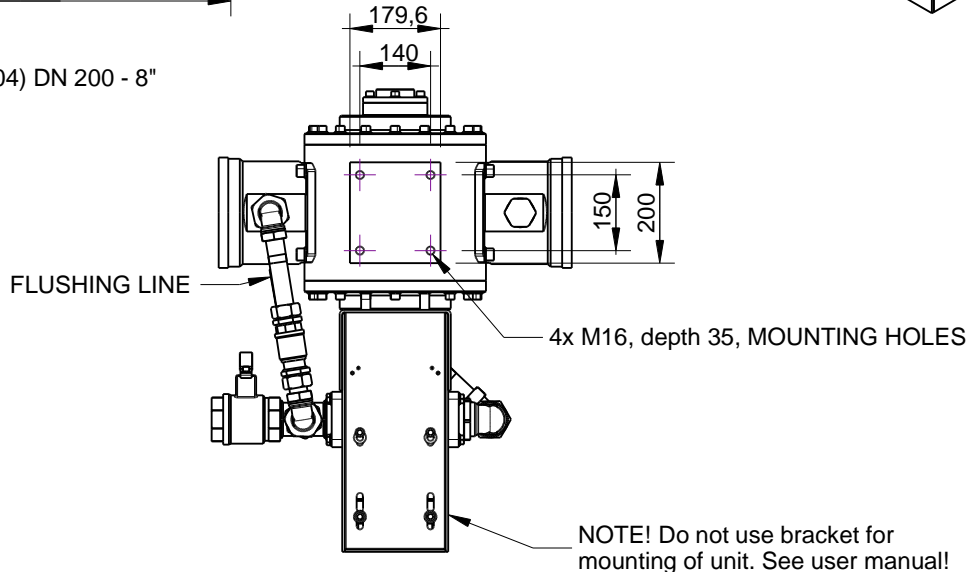
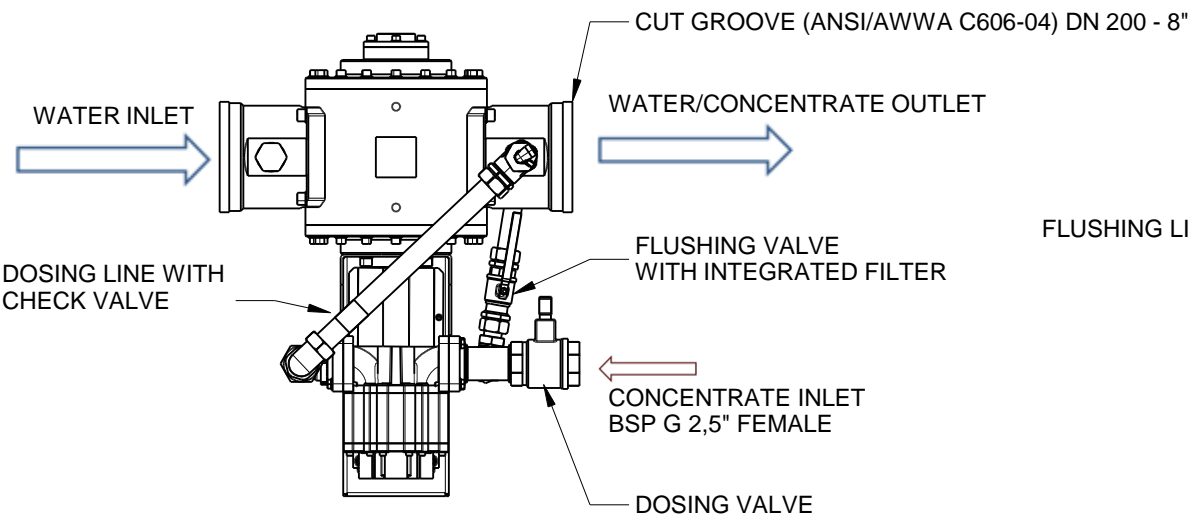

C

C

D

D

Dimension tolerance ± 1 mm unless otherwise stated

NOTE! Reverse water flow direction is optional

We reserve the right to make design changes without prior notice

Drawn by WALLE	Checked by	Approved by - date	File name	Date 2015-06-04	Scale 1:15
Firemiks AB P.O.Box 8155 SE-104 20 STOCKHOLM, Sweden info@firemiks.com +46-8-551 196 10			FIREMIKS FM 8000-3-GP		
Copyright of Firemiks AB All rights reserved				Edition	Sheet

1

2

3

6